

NOMAD



# NOMAD™

## OPERATION MANUAL

### NTG15 NOMAD TRANS-FLO™

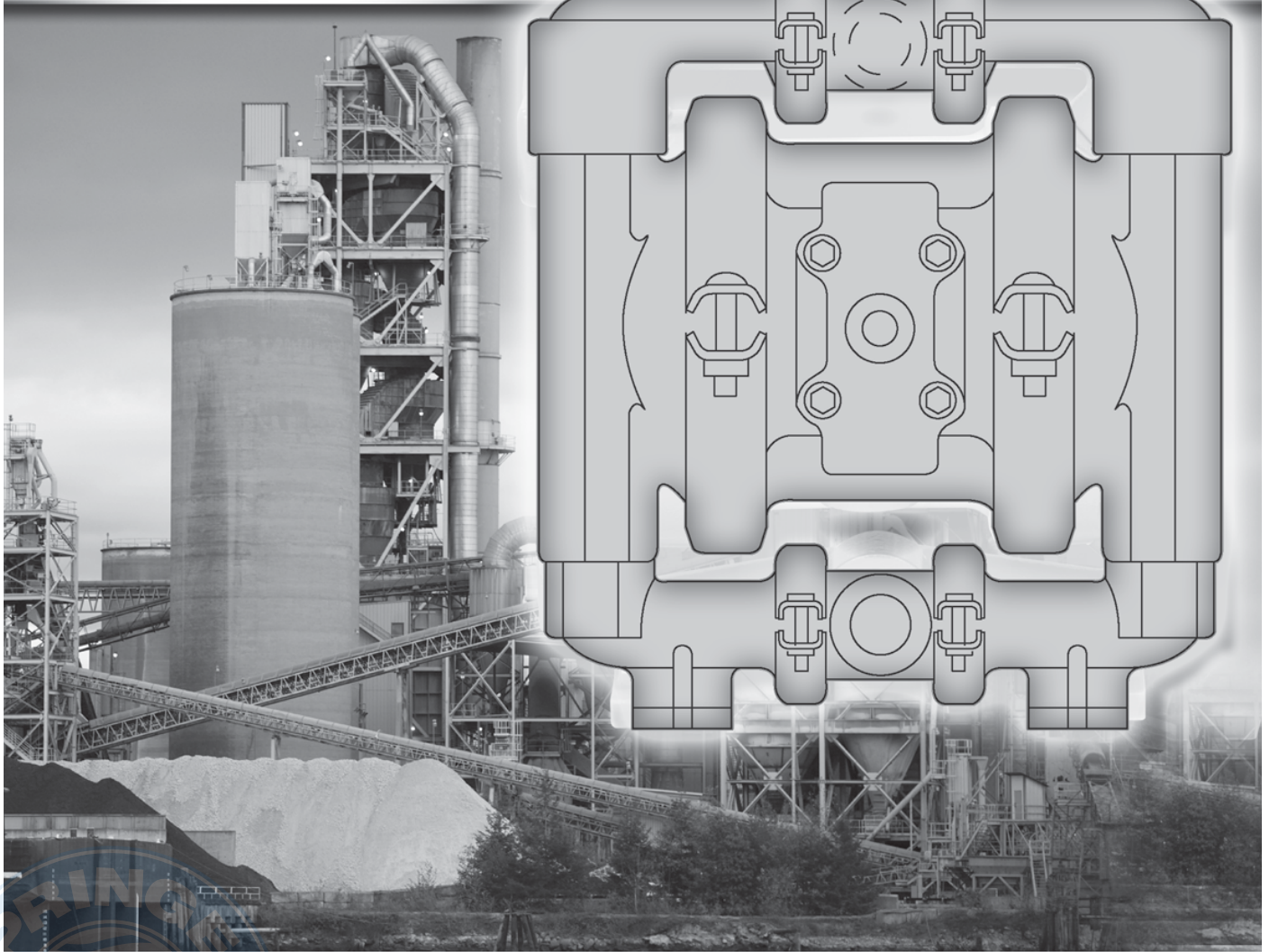

AIR-OPERATED



DOUBLE DIAPHRAGM



PUMPS

**ALUMINUM** Models

**316 S.S.** Models



A JDA Global Company

1/14 rev. 3

Tel: 866-777-6060  
Fax: 866-777-6383

Springer Pumps, LLC

Website: [www.springerpumps.com](http://www.springerpumps.com)  
Int'l: +001 267 404 2910

## CAUTION – SAFETY POINTS

| TEMPERATURE LIMITS: |                    |                |
|---------------------|--------------------|----------------|
| Neoprene            | -17.8°C to 93.3°C  | 0°F to 200°F   |
| Buna-N              | -12.2°C to 82.2°C  | 10°F to 180°F  |
| EPDM                | -51.1°C to 137.8°C | -60°F to 280°F |
| Viton®              | -40°C to 176.7°C   | -40°F to 350°F |
| Santoprene®         | -40°C to 107.2°C   | -40°F to 225°F |
| Polyurethane        | 12.2°C to 65.6°C   | 10°F to 150°F  |
| Hytrel®             | -28.9°C to 104.4°C | -20°F to 220°F |
| PTFE                | 4.4°C to 104.4°C   | 40°F to 220°F  |

1. Review the NOMAD Chemical Field Guide for all applications. The information provided is the “best thinking available” regarding chemical compatibility. The guide however, does not provide a recommendation.
2. Always wear safety glasses during pump operation. A diaphragm rupture may force liquid to exit via air exhaust.
3. When handling flammable fluids, prevent static sparking by properly grounding the pump.
4. Do not exceed 125 psig (8.6 bar).
5. Prior to maintenance, compressed air line should be disconnected to allow air pressure to bleed from pump.
6. Tighten all clamp bands and hardware parts prior to installation. Fittings may loosen during transportation.

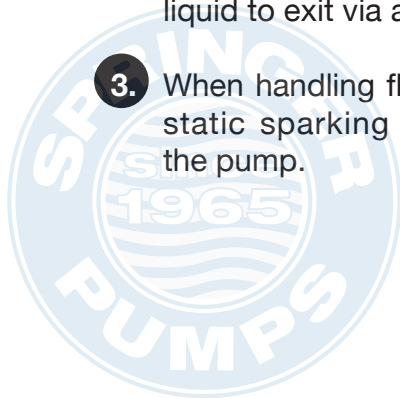

## PUMP DESIGNATION SYSTEM

**15 mm (1/2") Pump**  
**Maximum Flow Rate:**  
**54.9 lpm (14.5 gpm)**

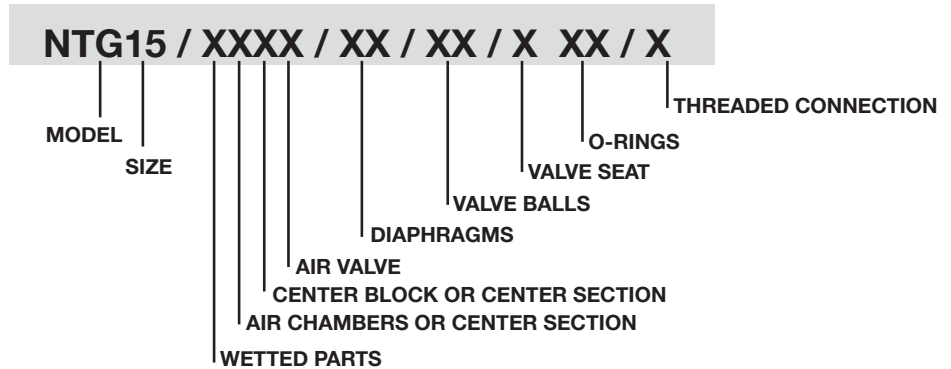

## MATERIAL CODES

### MODEL

NTG15 = 15MM (1/2")

### WETTED PARTS & OUTER PISTON

AA = ALUMINUM / ALUMINUM  
 S = 316 S.S.

### AIR CHAMBERS

P = POLYPROPYLENE  
 (CENTER SECTION)

### CENTER BLOCK

P = POLYPROPYLENE

### AIR VALVE

B = BRASS

### DIAPHRAGMS

BN = BUNA-N (Red Dot)  
 FS = HYTREL  
 ND = EPDM (Blue Dot)  
 NE = NEOPRENE (Green Dot)  
 SN = SANTOPRENE  
 TF = PTFE

### VALVE BALL

BN = BUNA-N (Red Dot)  
 FS = HYTREL  
 ND = EPDM (Blue Dot)  
 NE = NEOPRENE (Green Dot)  
 TF = PTFE (White)  
 SN = SANTOPRENE

### VALVE SEAT

A = ALUMINUM\*  
 S = STAINLESS\*  
 \*Valve seat o-ring required.

### VALVE SEAT O-RING

BN = BUNA-N  
 FS = HYTREL  
 ND = EPDM  
 NE = NEOPRENE  
 SN = SANTOPRENE  
 TF = PTFE

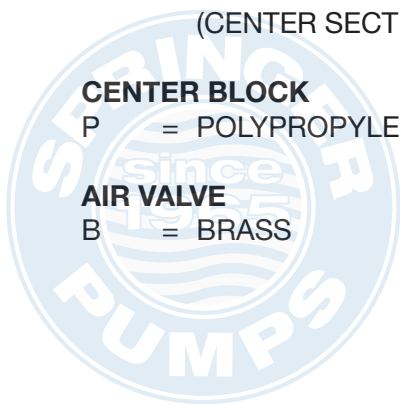

## AIR OPERATED DOUBLE DIAPHRAGM PUMPS FUNCTIONALITY AND FLOW PATTERN

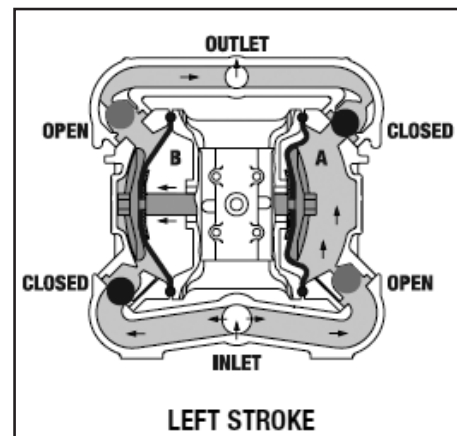
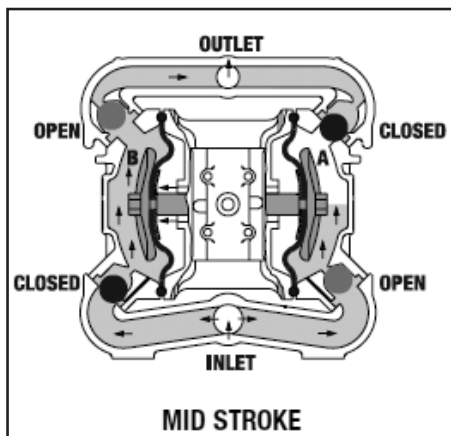
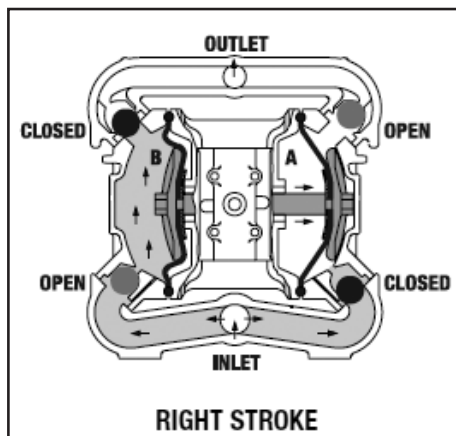
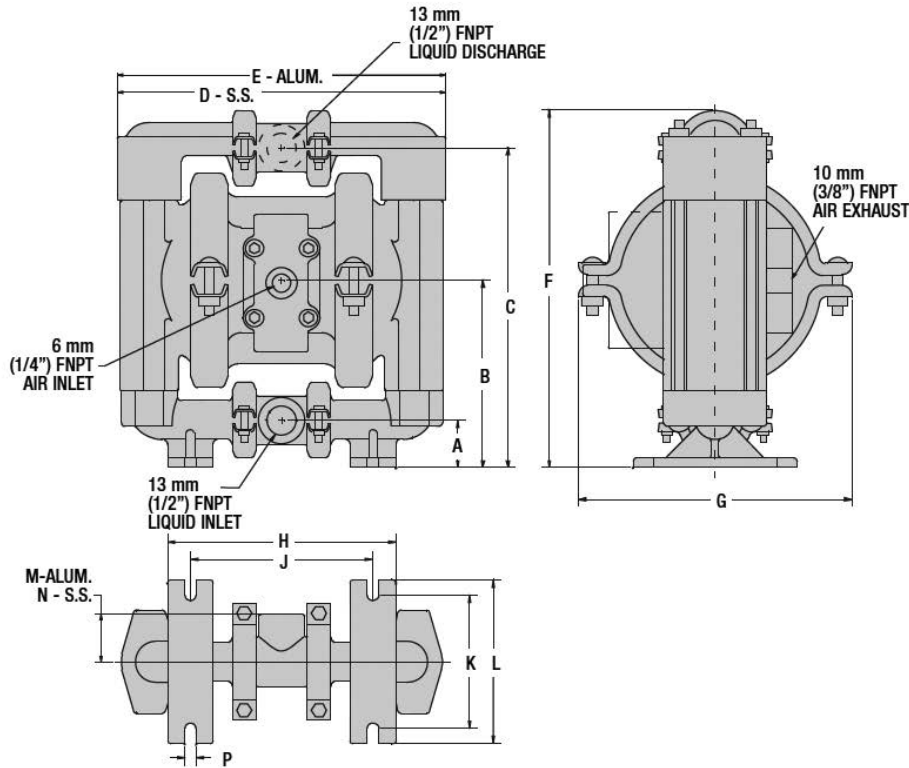

**Figure 1:** Air valve directs pressurized air to the back side of diaphragm A. Compressed air is applied directly to the liquid column separated by elastomeric diaphragms. The diaphragm acts as a separation membrane between the compressed air and liquid, balancing the load and removing mechanical stress from the diaphragm. The opposite diaphragm is pulled in by the shaft connected to the pressurized diaphragm. Diaphragm B is on its suction stroke; air behind the diaphragm has been forced out to the atmosphere through the exhaust port of the pump. Atmospheric pressure forces fluid into the inlet manifold forcing the inlet valve ball off its seat. Liquid is free to move past the inlet valve ball and fill the liquid chamber (see shaded area).

**Figure 2:** When the pressurized diaphragm, diaphragm A, reaches the limit of its discharge stroke, the air valve redirects pressurized air to the back side of the diaphragm B. The pressurized air forces diaphragm B away from the center block while pulling diaphragm A to the center block. Diaphragm B is now on its discharge stroke. These same hydraulic forces lift the discharge valve ball off its seat, while the opposite discharge valve ball is forced onto its seat, forcing fluid to flow through the pump discharge. Atmospheric pressure forces fluid into the inlet manifold of the pump. The inlet valve ball is forced off its seat allowing the fluid being pumped to fill the liquid chamber.

**Figure 3:** At completion of the stroke, the air valve again redirects air to the back side of diaphragm A, which starts diaphragm B on its exhaust stroke. As the pump reaches its original starting point, each diaphragm has gone through one exhaust and one discharge stroke. This constitutes one complete pumping cycle. The pump may take several cycles to completely prime depending on the conditions of the application.

## DIMENSIONAL DRAWINGS



## DIMENSIONS

| ITEM | METRIC (mm) | STANDARD (inch) |
|------|-------------|-----------------|
| A    | 28          | 1.1             |
| B    | 117         | 4.6             |
| C    | 198         | 7.8             |
| D    | 203         | 8.0             |
| E    | 208         | 8.2             |
| F    | 224         | 8.8             |
| G    | 175         | 6.9             |
| H    | 140         | 5.5             |
| J    | 112         | 4.4             |
| K    | 84          | 3.3             |
| L    | 102         | 4.0             |
| M    | 30          | 1.2             |
| N    | 30          | 1.2             |
| P    | 8           | 0.3             |

BSP threads available for liquid inlet and discharge.



## PERFORMANCE NTG15 METAL RUBBER-FITTED

Height.....224 mm (8.8")  
 Width.....208 mm (8.2")  
 Depth.....178 mm (7.0")  
 Est. Ship Weight.....Aluminum 6 kg (13 lbs)  
 316 S.S. 9 kg (20 lbs)  
 Air Inlet.....6 mm (1/4")  
 Inlet.....13 mm (1/2")  
 Outlet.....13 mm (1/2")  
 Suction Lift.....1.22 m Dry (4')  
 9.14 m Wet (30')  
 Displacement/Stroke.....0.06 l (0.017 gal.)<sup>1</sup>  
 Max. Flow Rate.....54.9 lpm (14.5 gpm)  
 Max. Size Solids.....1.6 mm (1/16")

<sup>1</sup>Displacement per stroke was calculated at 4.8 bar (70 psig) air inlet pressure against a 2 bar (30 psig) head pressure.

**Example:** To pump 22.7 lpm (6.0 gpm) against a discharge pressure head of 2.7 bar (40 psig) requires 4 bar (60 psig) and 10.2 Nm<sup>3</sup>/h (6 scfm) air consumption. (See dot on chart.)

**Caution: Do not exceed 8.6 bar (125 psig) air supply pressure.**

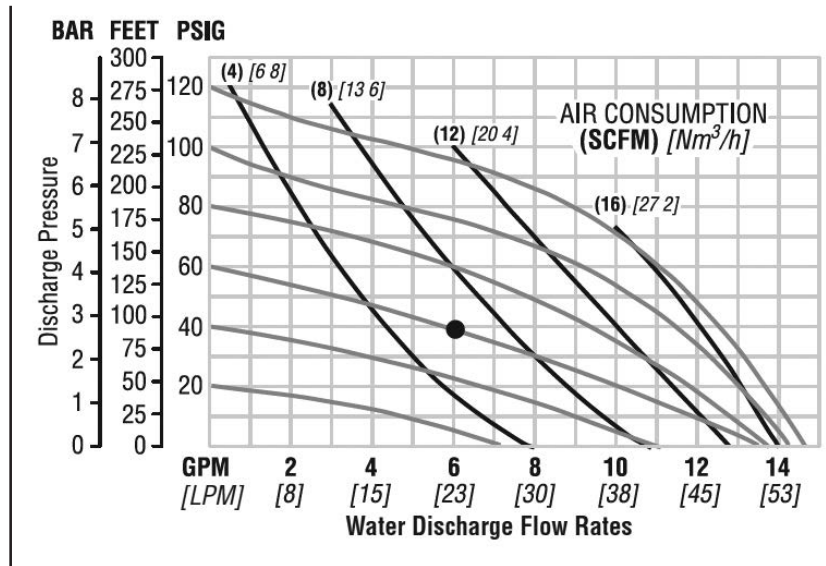

Flow rates indicated on chart were determined by pumping water.

For optimum life and performance, pumps should be specified so that daily operation parameters will fall in the center of the pump performance curve.

## PERFORMANCE NTG15 METAL PTFE-FITTED

Height.....224 mm (8.8")  
 Width.....208 mm (8.2")  
 Depth.....178 mm (7.0")  
 Est. Ship Weight.....Aluminum 6 kg (13 lbs)  
 316 S.S. 9 kg (20 lbs)  
 Air Inlet.....6 mm (1/4")  
 Inlet.....13 mm (1/2")  
 Outlet.....13 mm (1/2")  
 Suction Lift.....2.74 m Dry (1')  
 9.14 m Wet (30')  
 Displacement/Stroke.....0.05 l (0.014 gal.)<sup>1</sup>  
 Max. Flow Rate.....53 lpm (14 gpm)  
 Max. Size Solids.....1.6 mm (1/16")

<sup>1</sup>Displacement per stroke was calculated at 4.8 bar (70 psig) air inlet pressure against a 2 bar (30 psig) head pressure.

**Example:** To pump 22.7 lpm (6.0 gpm) against a discharge pressure head of 2 bar (30 psig) requires 4 bar (60 psig) and 10.2 Nm<sup>3</sup>/h (6 scfm) air consumption. (See dot on chart.)

**Caution: Do not exceed 8.6 bar (125 psig) air supply pressure.**

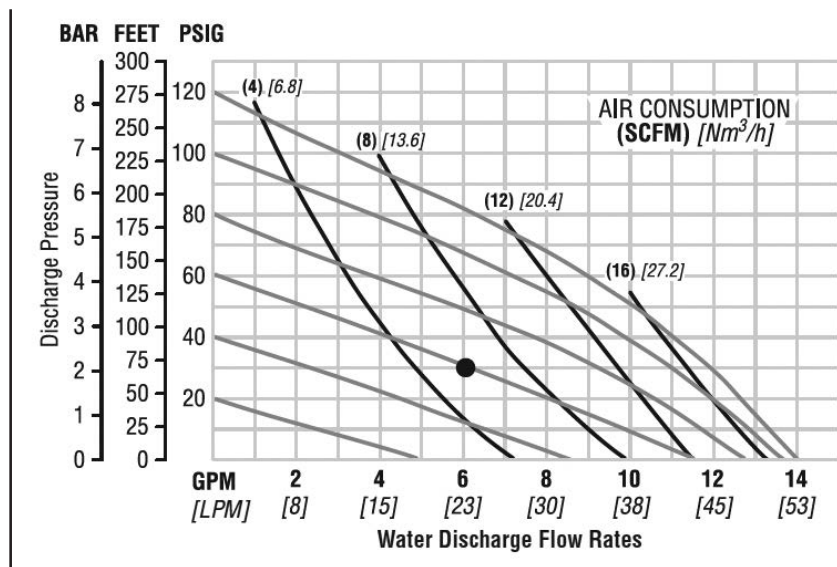

Flow rates indicated on chart were determined by pumping water.

For optimum life and performance, pumps should be specified so that daily operation parameters will fall in the center of the pump performance curve.

## SUGGESTED INSTALLATION

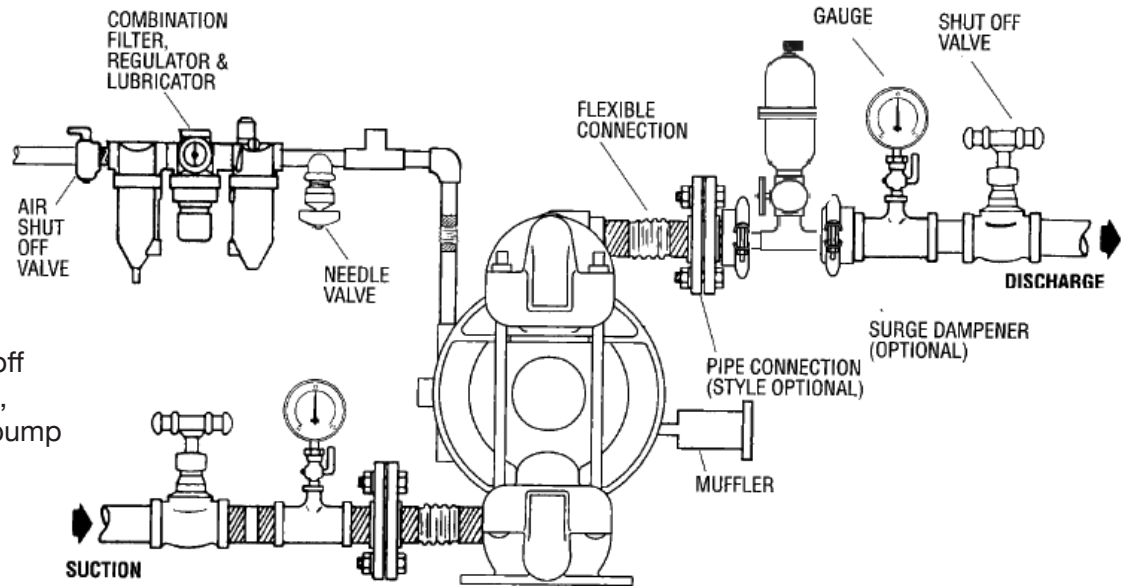

Note: In the event of a power failure, the shutoff valve should be closed, if the restarting of the pump is not desirable once power is regained.

## TROUBLESHOOTING

### ***Pump will not run or runs slowly.***

1. Check air inlet screen and air filter for debris.
2. Check for sticking air valve, flush air valve in solvent.
3. Check for worn out air valve. If piston face in air valve is shiny instead of dull, air valve is worn beyond working tolerances and must be replaced.
4. Check center block rings. If worn excessively, they will not seal and air will simply flow through pump and out air exhaust.
5. Check type of lubricant being used. ISO 15-5 wt. recommended.

### ***Pump runs but little or no product flows.***

1. Check for pump cavitation; slow pump speed down to match thickness of material being pumped.
2. Check for sticking ball valves. If material being pumped is not compatible with pump elastomers, swelling may occur.
3. Make sure all suction connections are air tight.

### ***Pump air valve freezes.***

Check for excessive moisture in compressed air.

### ***Air bubbles in pump discharge.***

1. Check for ruptured diaphragm.
2. Check for tightness for clamp bands, especially at intake manifold.

### ***Product comes out air exhaust.***

1. Check for diaphragm rupture.
2. Check tightness of piston plates to shaft.

### ***Pump rattles.***

Create false discharge head or suction lift.

## DISASSEMBLY/REASSEMBLY

### Tools Required:

5/16" Wrench

3/8" Box Wrench

7/16" Wrench

3/16" Allen Wrench

Adjustable Wrench

Vise equipped with soft jaws (such as plywood, plastic or other suitable materials)

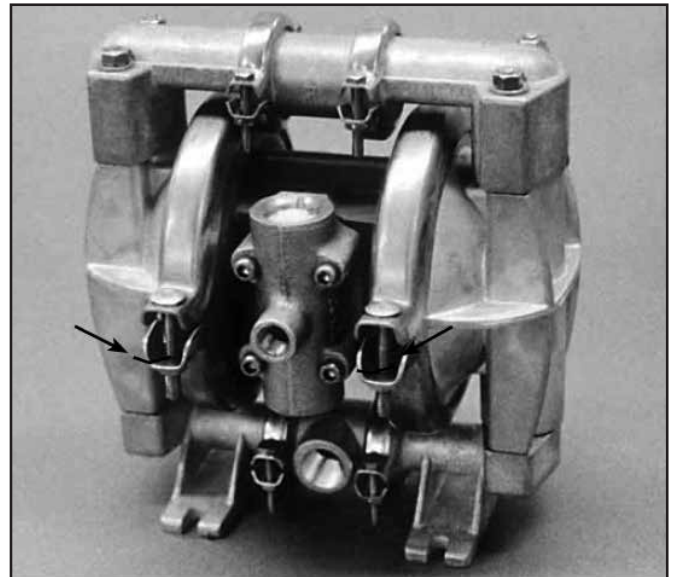

**Step 1:** Before starting disassembly, mark a line from each liquid chamber to its corresponding air chamber. This line will assist in proper alignment during reassembly.

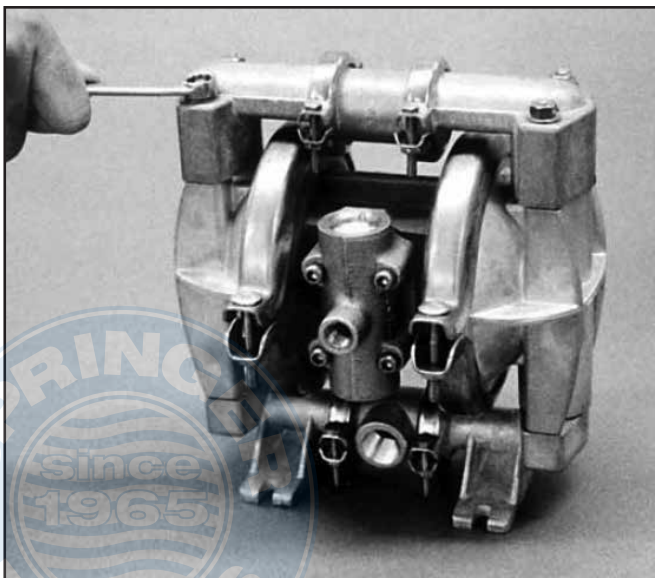

**Step 2:** Utilizing the 3/8" box wrench, start by removing the four long carriage bolts that secure the top and bottom manifolds to the center section.

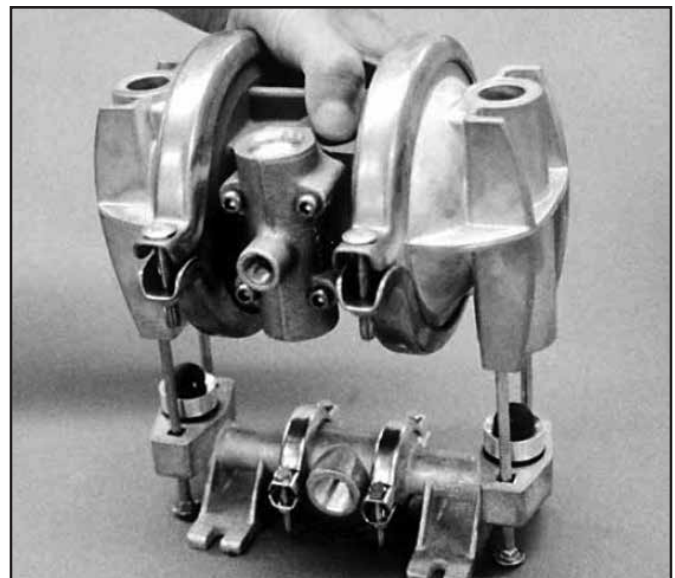

**Step 3:** Remove the top manifold and lift the center section off the inlet manifold.



## DISASSEMBLY/REASSEMBLY

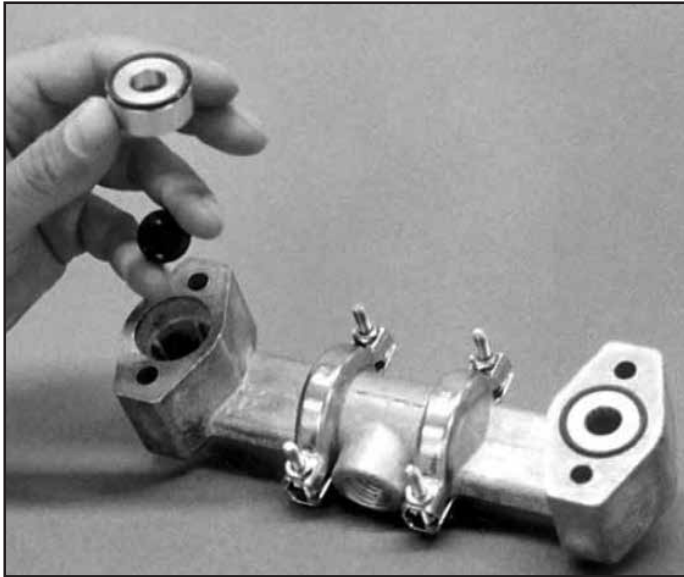

**Step 4:** Remove the discharge valve balls, seats and o-rings from the discharge manifold and inspect for nicks, gouges, chemical attack or abrasive wear. PTFE o-rings should be replaced when reassembled.

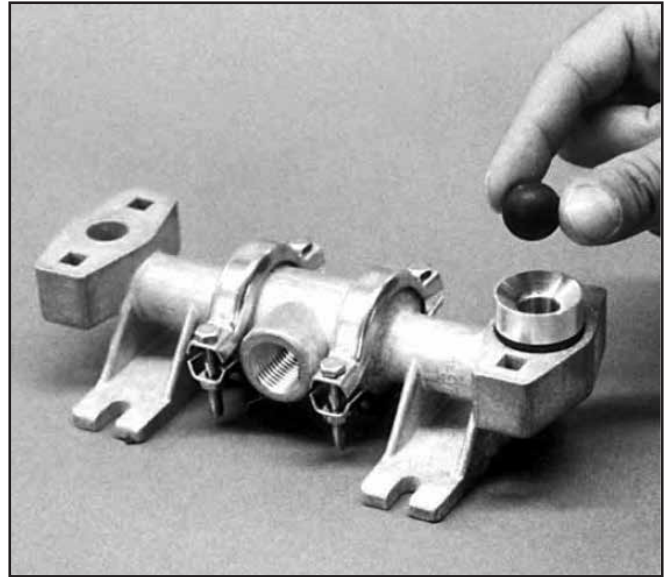

**Step 5:** Inspect the ball retainer, retainer o-ring, and valve ball from the intake manifold. Check for nicks, gouges, chemical attack or abrasive wear. PTFE o-rings should be replaced when reassembled.



**Step 6:** Normally the inlet and discharge manifold should not be disassembled during regular pump maintenance. Should this be necessary, completely remove and disassemble manifold clamp bands.

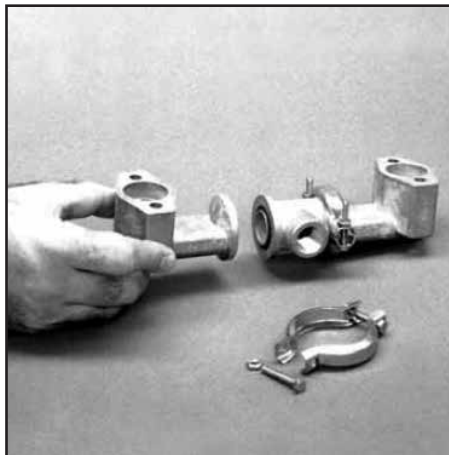

**Step 7:** Inspect o-rings for wear or damage and replace if necessary. PTFE o-rings should be replaced when reassembled.

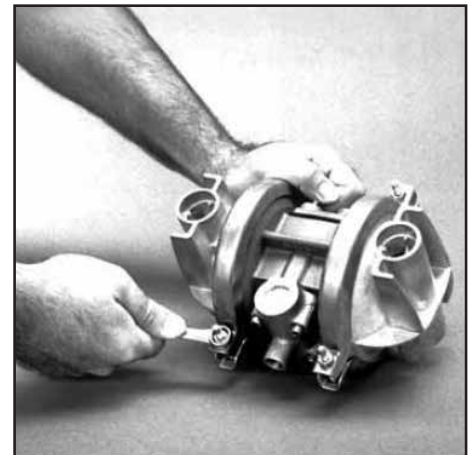

**Step 8:** Use a 7/16" wrench to remove one set of clamp bands that secure one liquid chamber to the one-piece center section.

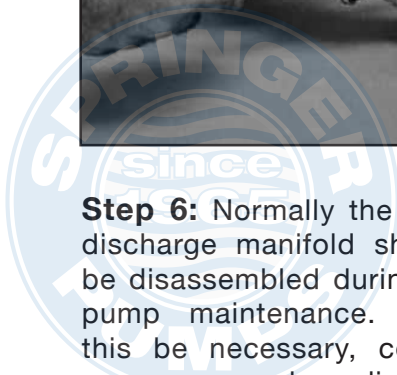

## DISASSEMBLY/REASSEMBLY

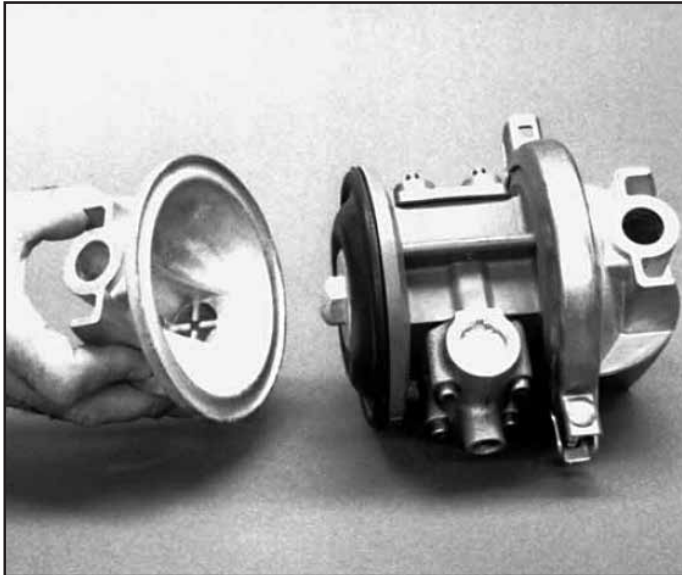

**Step 9:** Lift the liquid chamber away from the center section to expose the diaphragm and outer piston.



**Step 10:** Using an adjustable wrench, or by rotating the diaphragm by hand, remove the diaphragm assembly from the center section.



**Step 11a:** NOTE: Due to varying torque values, one of the following two situations may occur: 1) The outer piston, diaphragm and inner piston remain attached to the shaft and the entire assembly can be removed from the center section.

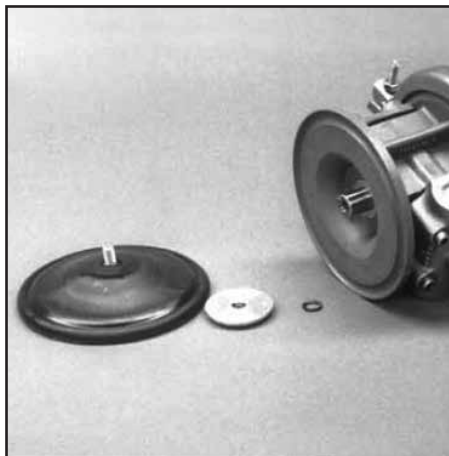

**Step 11b:** 2) The outer piston, diaphragm, inner piston, and disc spring separate from the shaft which remains connected to the opposite side diaphragm assembly. PTFE-fitted pumps come standard with back-up diaphragms (not shown).



**Step 12:** To remove the diaphragm assembly from the shaft, secure shaft with soft jaws (a vise fitted with plywood or other suitable material) to ensure shaft is not nicked, scratched, or gouged. Using an adjustable wrench, remove diaphragm assembly from shaft. Inspect all parts for wear and replace if necessary.

## CENTER BLOCK/SEAL DISASSEMBLY

### Center Block Assembly:

The pump's center block consists of a polypropylene or aluminum housing with a cast-in bronze bushing. The bushing has eight grooves cut on the inside diameter. There are four TRACKER™ seals that fit in these grooves. Since these TRACKER™ seals form a part of the shifting function of the pump, it is necessary that they be located in the proper grooves. When bushing wear becomes excessive, a new center block must be used.

Grooves in bushing which contain TRACKER™ seals

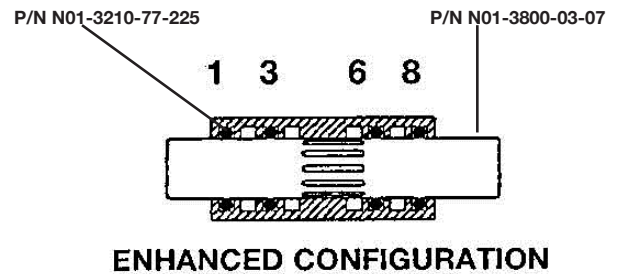

## EXPLODED VIEW (RUBBER DIAPHRAGMS)

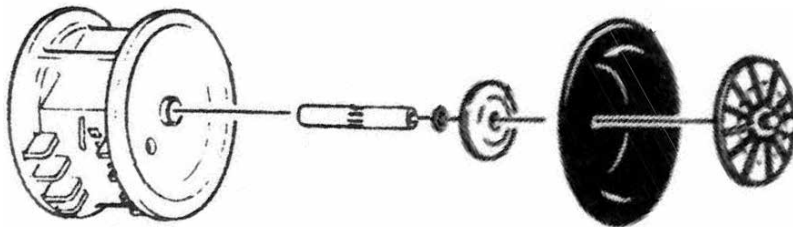

## EXPLODED VIEW (PTFE DIAPHRAGMS)

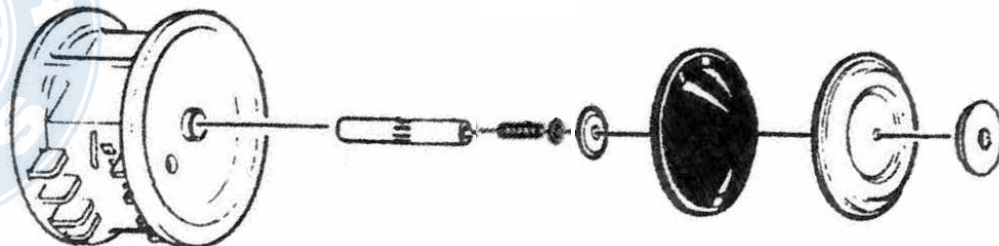

## NTG15 RUBBER-FITTED

| Item | Description                              | Qty. | Aluminum        | 316.S.S.        |
|------|--|------|-----------------|-----------------|
| 1    | Air Valve Assembly                       | 1    | N01-2012-07     | N01-2012-07     |
| 2    | Center Section                           | 1    | N01-3153-20     | N01-3153-20     |
| 3    | Center Block TRACKER™ Seal               | 4    | N01-3210-77-225 | N01-3210-77-225 |
| 4    | Shaft                                    | 1    | N01-3800-03-07  | N01-3800-03-07  |
| 5    | Outer Piston                             | 2    | N01-4570-01     | N01-4570-03     |
| 6    | Inner Piston                             | 2    | N01-3710-01     | N01-3710-01     |
| 7    | Air Valve Gasket                         | 1    | N01-2600-52     | N01-2600-52     |
| 8    | Muffler Plate Gasket                     | 1    | N01-3500-52     | N01-3500-52     |
| 9    | Muffler Plate                            | 1    | N01-3180-20     | N01-3180-20     |
| 10   | End Cap w/Guide                          | 1    | N01-2331-01     | N01-2331-01     |
| 11   | Pressure Differential Cap                | 1    | N01-2301-01     | N01-2301-01     |
| 12   | Buna-N O-Ring - 11570 Shore              | 2    | N01-2391-52     | N01-2391-52     |
| 13   | End Cap Snap Ring                        | 2    | N01-2651-01     | N01-2651-03     |
| 14   | Air Valve Cap Screw 1/4" - 20 x 4 -1/2"  | 4    | N01-6000-03     | N01-6000-03     |
| 15   | Air Valve Cap Screw Nut 1/4" - 20        | 4    | N04-6400-03     | N04-6400-03     |
| 16   | Liquid Chamber                           | 2    | N01-5000-01     | N01-5000-03     |
| 17   | Discharge Manifold Elbow                 | 2    | N01-5230-01     | N01-5230-03     |
| 18   | Inlet Manifold Elbow                     | 2    | N01-5220-01     | N01-5220-03     |
| 19   | Manifold "T" Section                     | 2    | N01-5160-01     | N01-5160-03     |
| 20   | Clamp Band (Large) Assembly              | 2    | N01-7300-03     | N01-7300-03     |
| 21   | Clamp Band (Small) Assembly              | 4    | N01-7100-03     | N01-7100-03     |
| 22   | Vertical Bolt 1/4" - 20 x 7/-3/8"        | 4    | N01-6080-03     | N01-6080-03     |
| 23   | Muffler                                  | 1    | N01-3510-99     | N01-3510-99     |
| 24   | Diaphragm                                | 2    | Selection       | Selection       |
| 25   | Valve Ball                               | 4    | Selection       | Selection       |
| 26   | Valve Seat                               | 4    | N01-1120-01     | N01-1120-03     |
| 27   | Valve Seat O-Ring                        | 4    | Selection       | Selection       |
| 28   | Manifold O-Ring                          | 4    | Selection       | Selection       |
| 29   | Small Clamp Band Bolt #10-24 x 1"        | 8    | N01-6101-03     | N01-6101-03     |
| 30   | Small Clamp Band Nut #10 -24             | 8    | N01-6400-03     | N01-6400-03     |
| 31   | Large Clamp Band Bolt 1/4" - 20 x 1-3/4" | 4    | N01-6070-03     | N01-6070-03     |
| 32   | Large Clamp Band Nut 1/4" - 20           | 4    | N01-6400-03     | N01-6400-03     |
| 33   | Shaft Stud                               | 2    | N/A             | N01-6150-03     |
| 34   | Vertical Bolt Nut 1/4" - 20              | 4    | N04-6400-03     | N04-6400-03     |
| 35   | Vertical Bolt Washer                     | 4    | N01-6730-03     | N01-6730-03     |
| 36   | Disc Spring                              | 2    | N01-6802-08     | N01-6802-08     |

## NTG15 RUBBER-FITTED

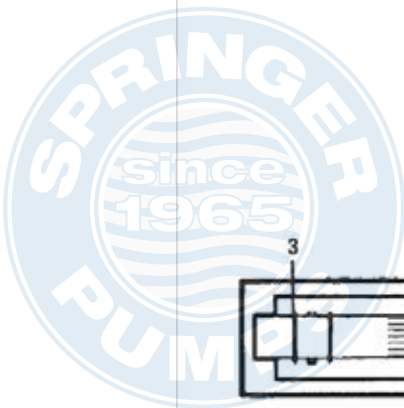
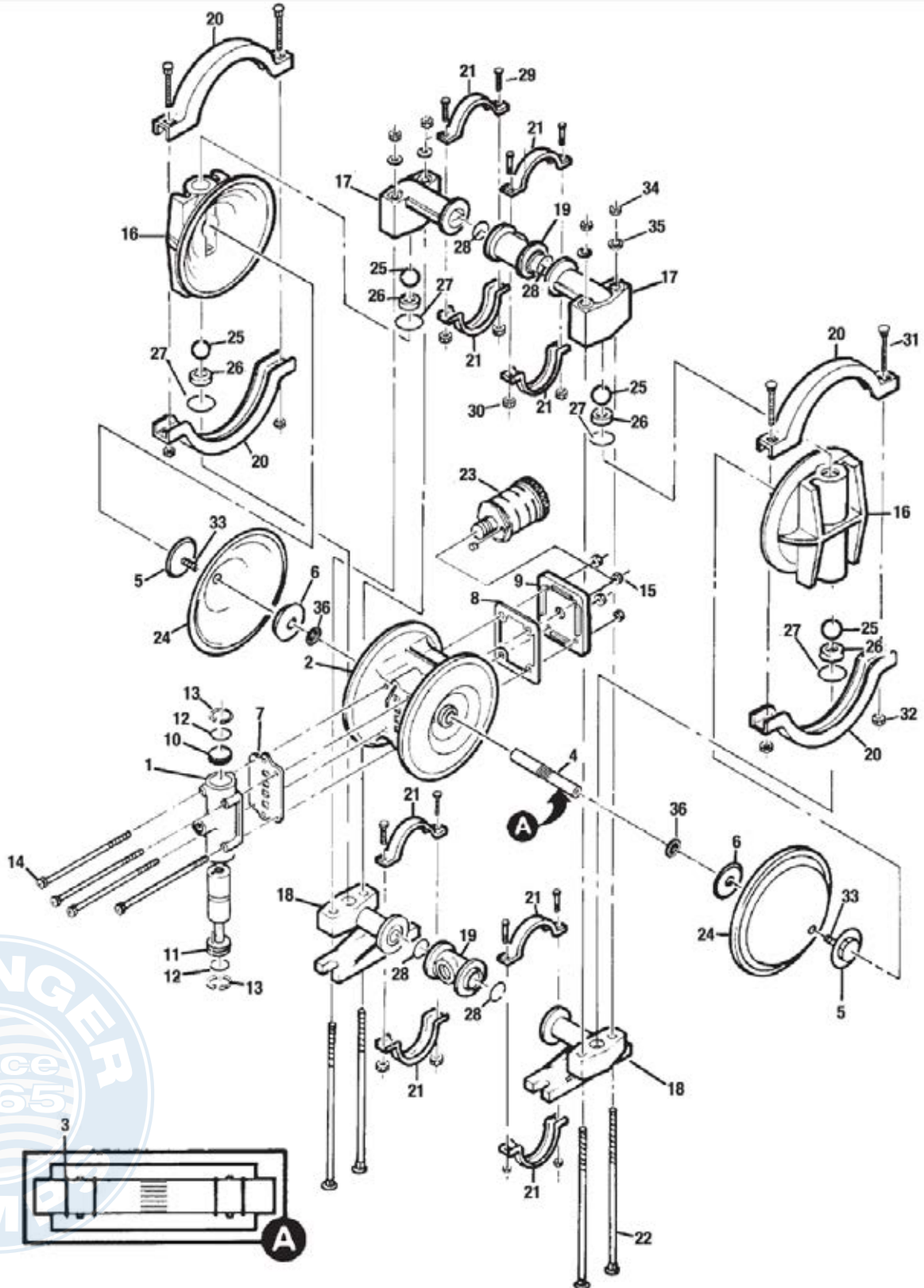

## NTG15 PTFE-FITTED

| Item | Description                              | Qty. | Aluminum        | 316.S.S.        |
|------|--|------|-----------------|-----------------|
| 1    | Air Valve Assembly                       | 1    | N01-2000-07     | N01-2012-07     |
| 2    | Center Section                           | 1    | N01-3153-20     | N01-3153-20     |
| 3    | Center Block TRACKER™ Seal               | 4    | N01-3210-77-225 | N01-3210-77-225 |
| 4    | Shaft                                    | 1    | N01-3800-03-07  | N01-3800-03-07  |
| 5    | Outer Piston                             | 2    | N01-4570-01     | N01-4570-03     |
| 6    | Inner Piston                             | 2    | N01-3710-01     | N01-3710-01     |
| 7    | Air Valve Gasket                         | 1    | N01-2600-52     | N01-2600-52     |
| 8    | Muffler Plate Gasket                     | 1    | N01-3500-52     | N01-3500-52     |
| 9    | Muffler Plate                            | 1    | N01-3180-20     | N01-3180-20     |
| 10   | End Cap w/Guide                          | 1    | N01-2331-01     | N01-2331-01     |
| 11   | Pressure Differential Cap                | 1    | N01-2301-01     | N01-2301-01     |
| 12   | Buna-N O-Ring - 11570 Shore              | 2    | N01-2391-52     | N01-2391-52     |
| 13   | End Cap Snap Ring                        | 2    | N01-2651-01     | N01-2651-03     |
| 14   | Air Valve Cap Screw 1/4" - 20 x 4 -1/2"  | 4    | N01-6000-03     | N01-6000-03     |
| 15   | Air Valve Cap Screw Nut 1/4" - 20        | 4    | N04-6400-03     | N04-6400-03     |
| 16   | Liquid Chamber                           | 2    | N01-5000-01     | N01-5000-03     |
| 17   | Discharge Manifold Elbow                 | 2    | N01-5230-01     | N01-5230-03     |
| 18   | Inlet Manifold Elbow                     | 2    | N01-5220-01     | N01-5220-03     |
| 19   | Manifold "T" Section                     | 2    | N01-5160-01     | N01-5160-03     |
| 20   | Clamp Band (Large) Assembly              | 2    | N01-7300-03     | N01-7300-03     |
| 21   | Clamp Band (Small) Assembly              | 4    | N01-7100-03     | N01-7100-03     |
| 22   | Vertical Bolt 1/4" - 20 x 7/-3/8"        | 4    | N01-6080-03     | N01-6080-03     |
| 23   | Muffler                                  | 1    | N01-3510-99     | N01-3510-99     |
| 24   | Diaphragm                                | 2    | N01-1010-55     | N01-1010-55     |
| 25   | Valve Ball                               | 4    | N01-1080-55     | N01-1080-55     |
| 26   | Valve Seat                               | 4    | N01-1120-01     | N01-1120-03     |
| 27   | Valve Seat O-Ring                        | 4    | N01-1200-55     | N01-1200-55     |
| 28   | Manifold O-Ring                          | 4    | N01-1300-55     | N01-1300-55     |
| 29   | Back-Up Diaphragm                        | 2    | N01-1060-51     | N01-1060-51     |
| 30   | Small Clamp Band Bolt #10-24 x 1"        | 8    | N01-6101-03     | N01-6101-03     |
| 31   | Small Clamp Band Nut #10 -24             | 8    | N01-6400-03     | N01-6400-03     |
| 32   | Large Clamp Band Bolt 1/4" - 20 x 1-3/4" | 4    | N01-6070-03     | N01-6070-03     |
| 33   | Large Clamp Band Nut 1/4" - 20           | 4    | N01-6400-03     | N01-6400-03     |
| 34   | Shaft Stud                               | 2    | N/A             | N01-6150-03     |
| 35   | Vertical Bolt Nut 1/4" - 20              | 4    | N04-6400-03     | N04-6400-03     |
| 36   | Vertical Bolt Washer                     | 4    | N01-6730-03     | N01-6730-03     |
| 37   | Disc Spring                              | 2    | N01-6802-08     | N01-6802-08     |

## NTG15 PTFE-FITTED

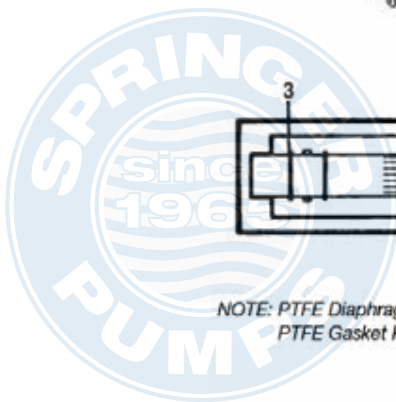
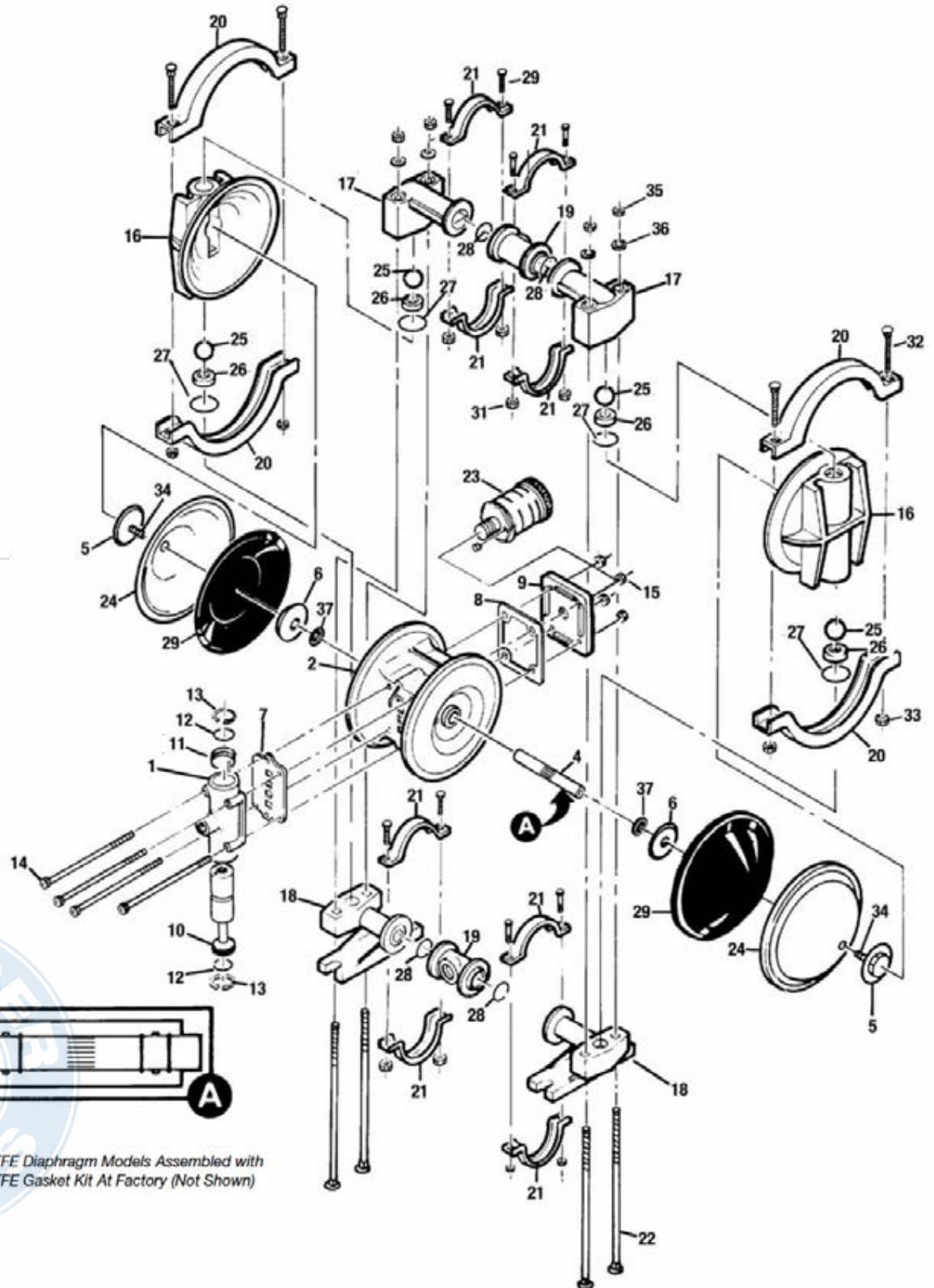



A JDA Global Company

1351 Park Ave., Suite 104  
Redlands, CA USA 92373  
(909) 798-9532

N O M A D



NO BOUNDARIES™



Tel: 866-777-6060  
Fax: 866-777-6383

Springer Pumps, LLC

Website: [www.springerpumps.com](http://www.springerpumps.com)  
Int'l: +001 267 404 2910